

INSTRUCTION

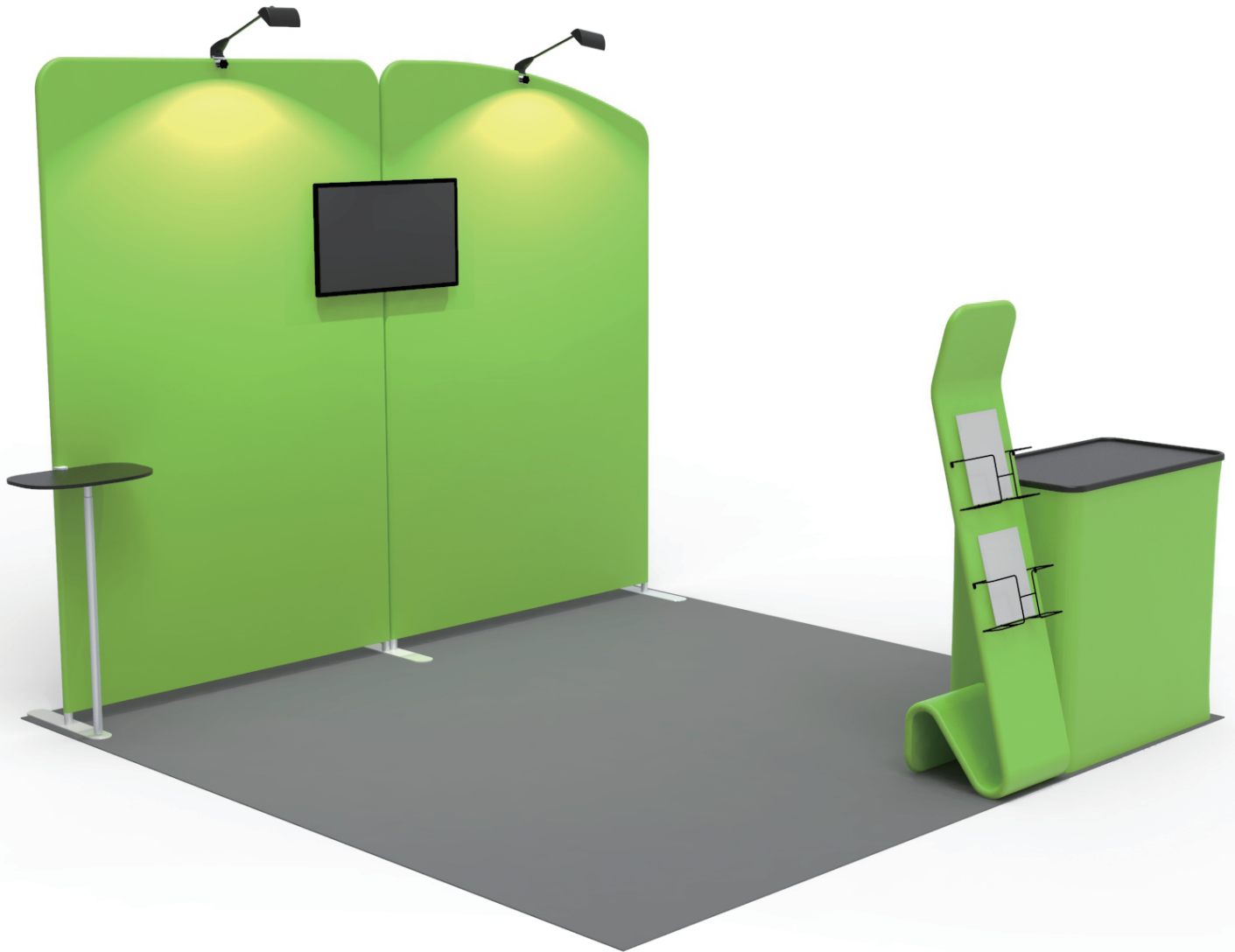

10X10FT-BOOTH-A1

STEPS

(1) Hardware

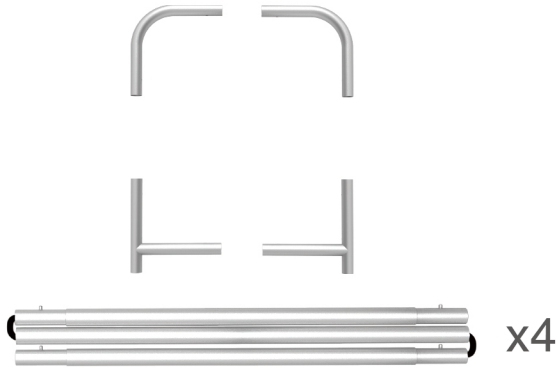

(2) Printed Graphic Fabric Banner (Optional)



STEP 01

Connect to make long poles according to labelings.

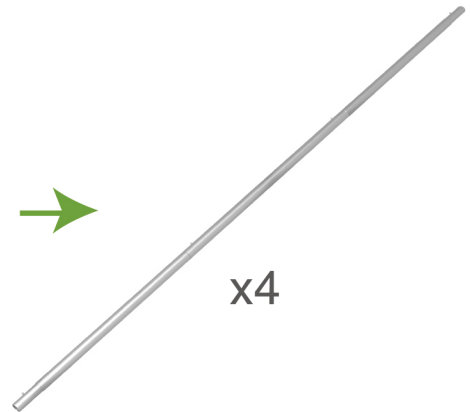
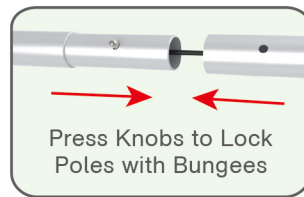
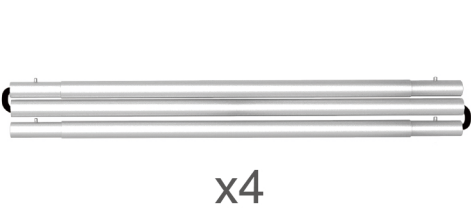

STEP 02

Connect long poles with corner poles according to labelings.

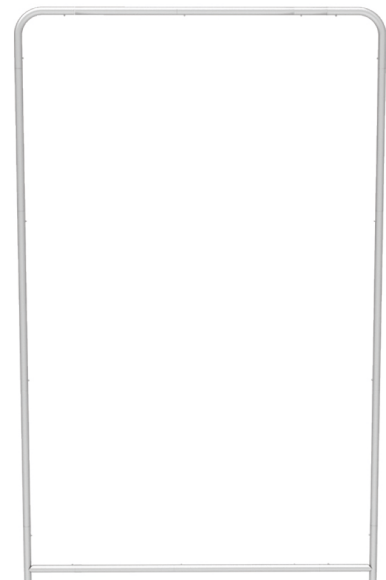
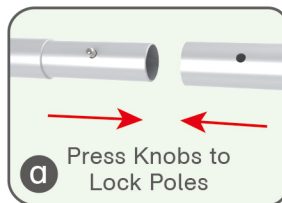
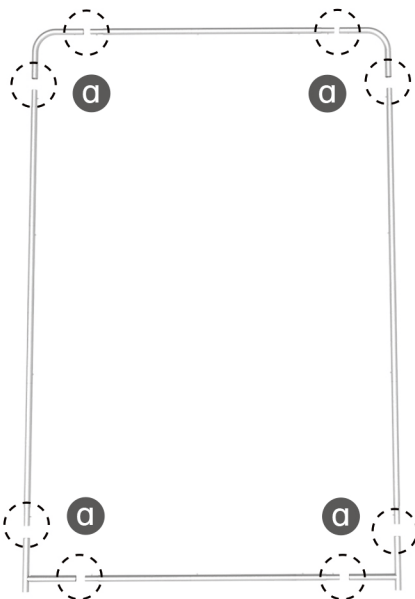

STEPS

STEP 03 Slide fabric banner on frame from top and zip up at bottom.

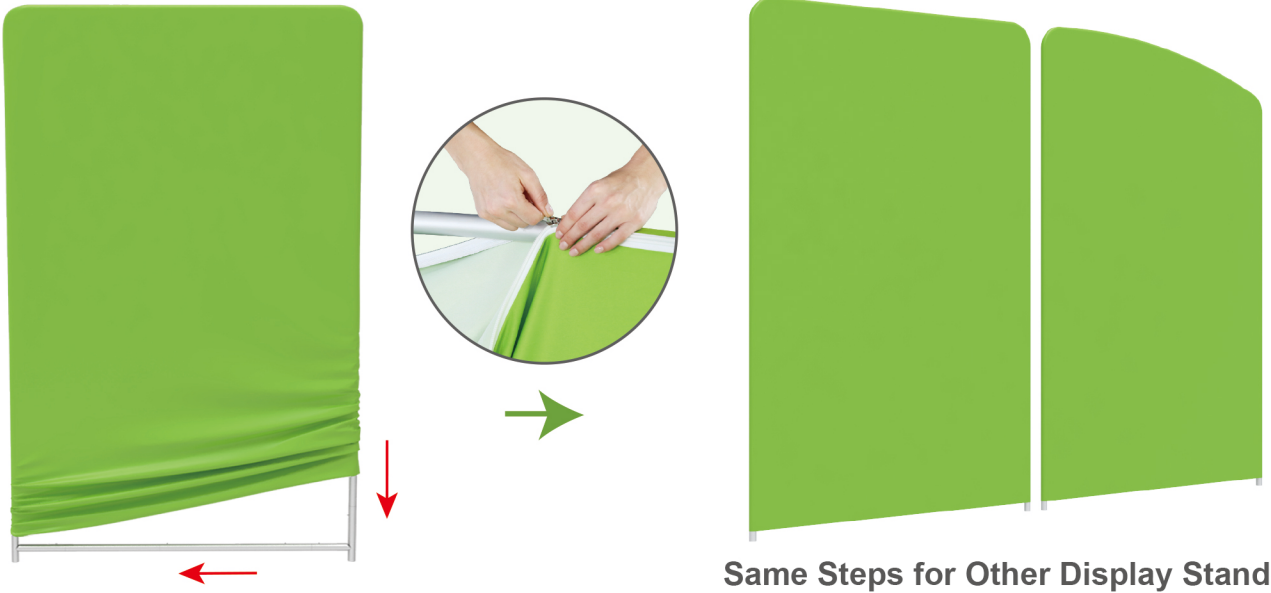

Booth Set Assembly



(1) Base

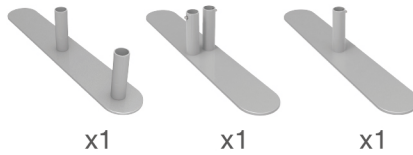

(2) LED Light & Clip



(3) MDF Board Table

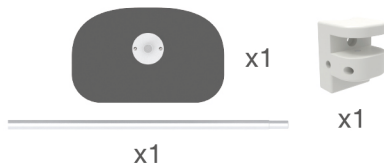

(4) C-Shaped Clip & TV Mount

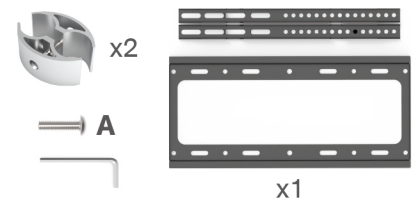

STEP 01 Insert display stands onto feet by pressing their knobs.

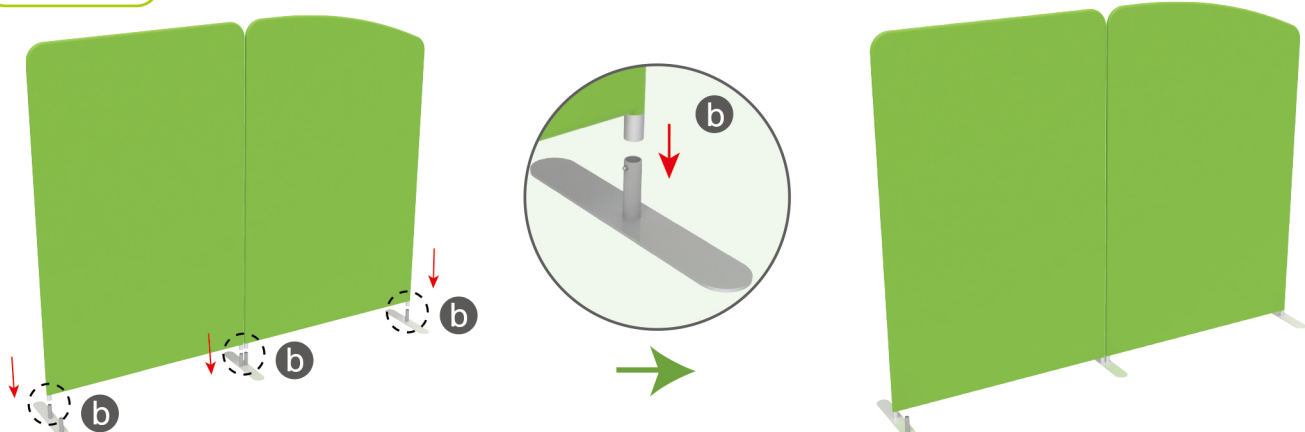

STEPS

STEP 02 Interconnect display stands with C-shaped clips.

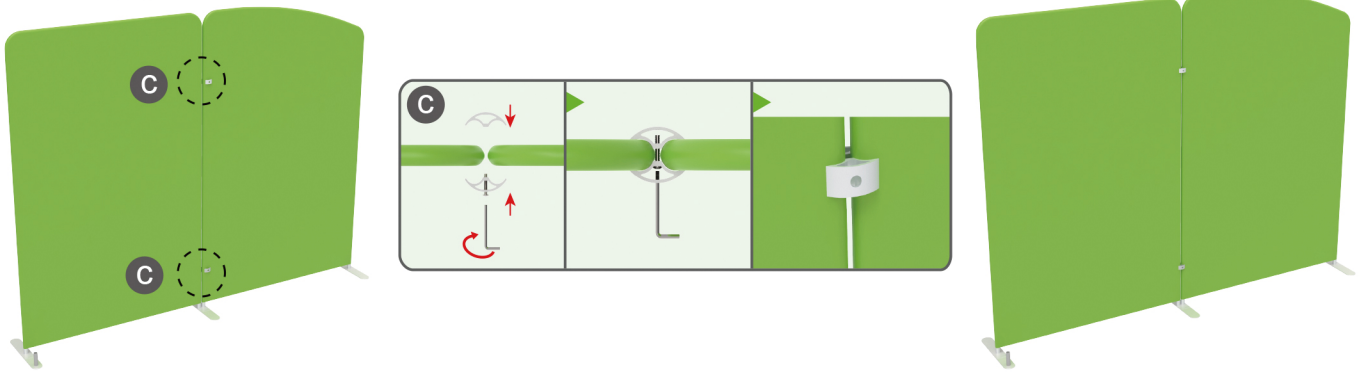

STEP 03

Insert pole into base, screw clamp with hex wrench, place MDF board onto pole & insert into clamp with screw.

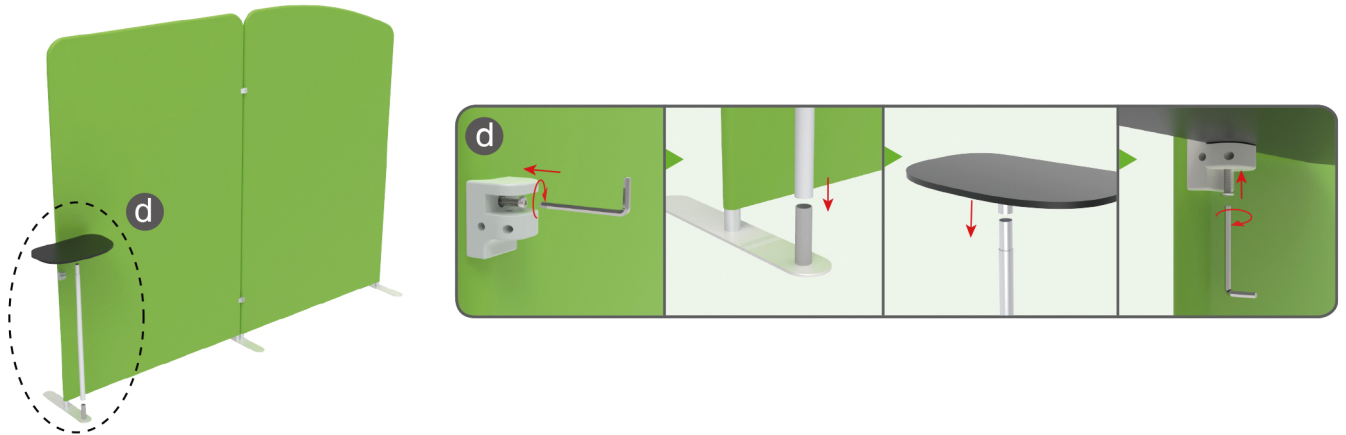

STEP 04 Screw TV mount with hex wrench.

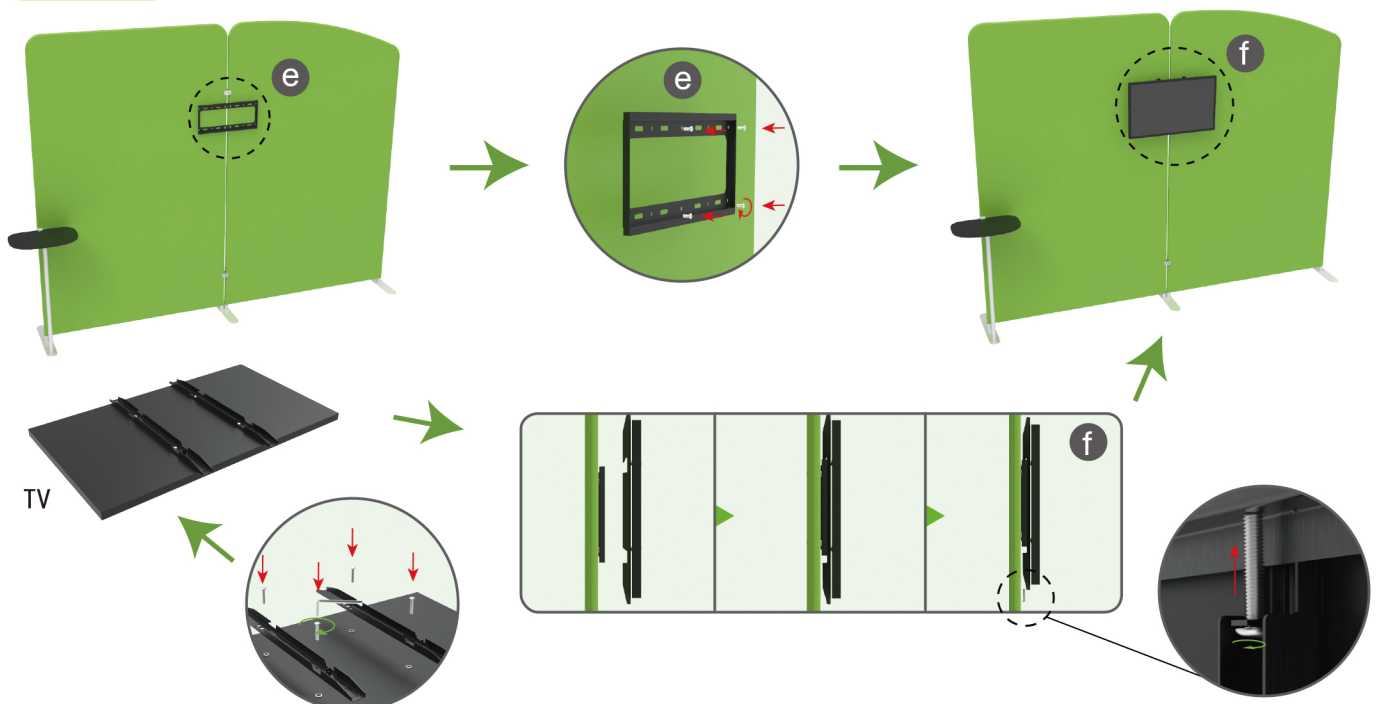

STEPS

STEP 05

Screw light clips at top of display stands, slide lights onto them and adjust their direction.

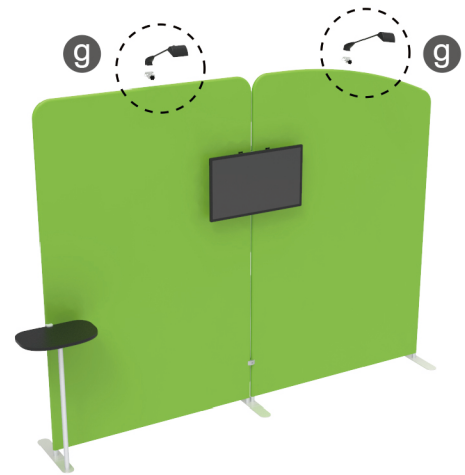
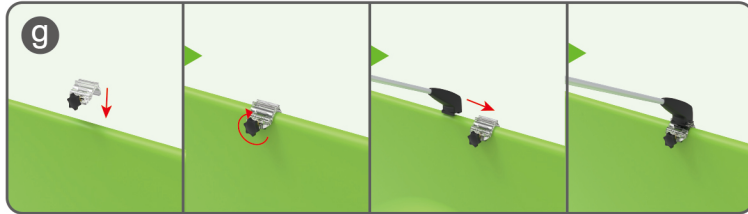

Same Steps for These Booths



10X10FT-BOOTH-A1

STEPS

(1) Durable Plastic Hard Case, Aluminum Support Poles



(2) Printed Graphic Fabric Banner



STEP 01

Put hard case's top into fabric banner.

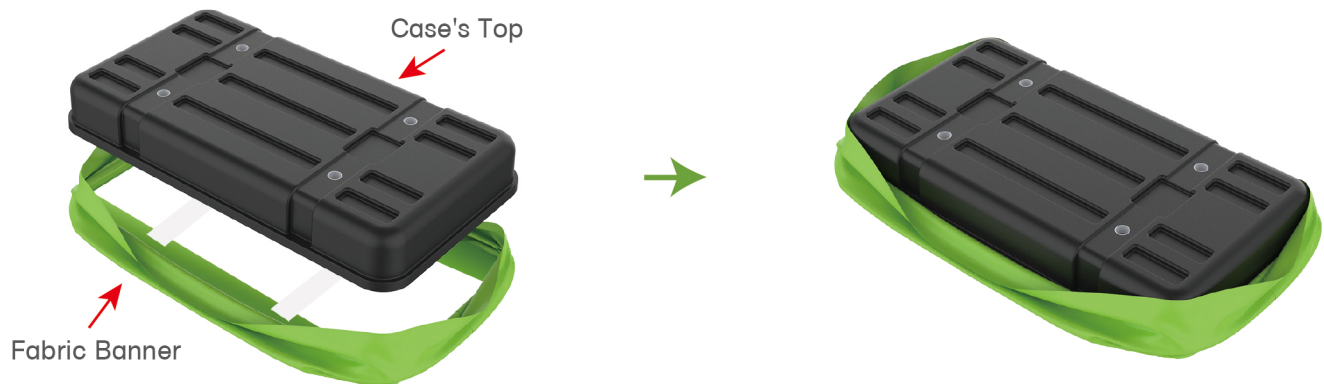

STEP 02

Insert support poles into hard case's top & bottom.

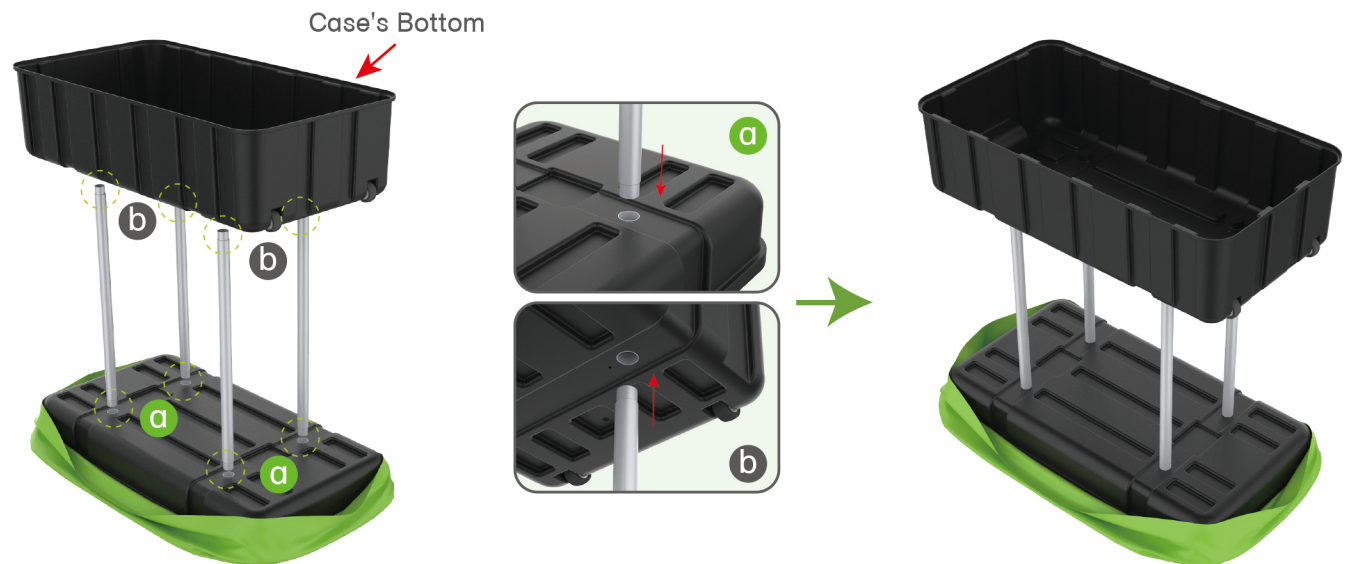

STEPS

STEP 04

Wrap fabric banner from bottom to top & twist it to be smooth, lay hard case's intermediate panel on podium's top.

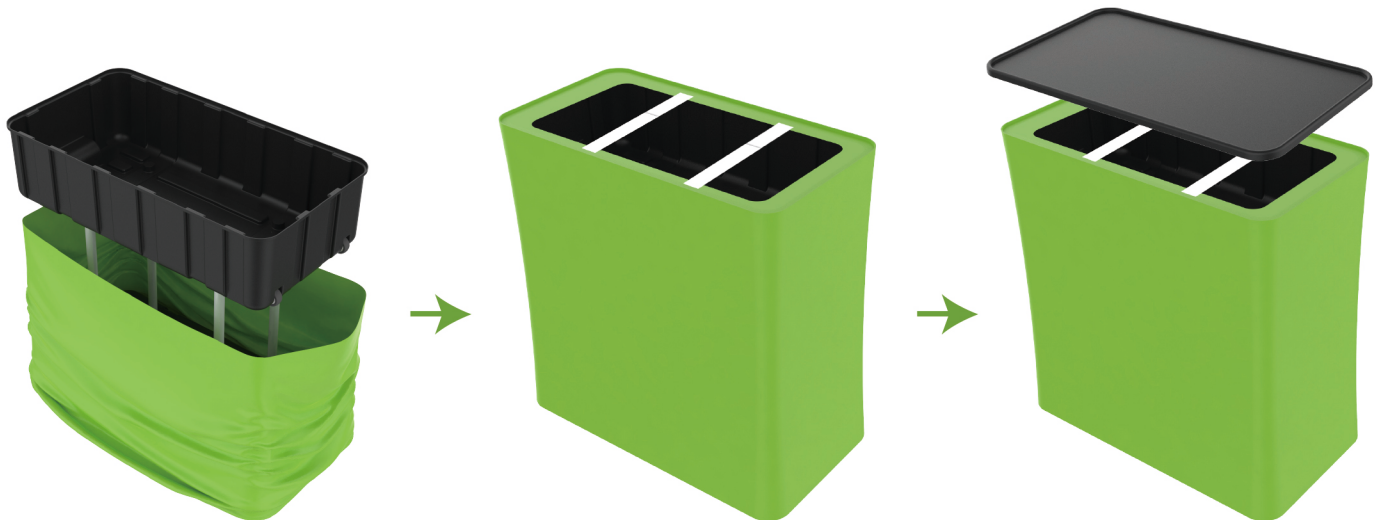

STEPS

(1) Snap Tubes

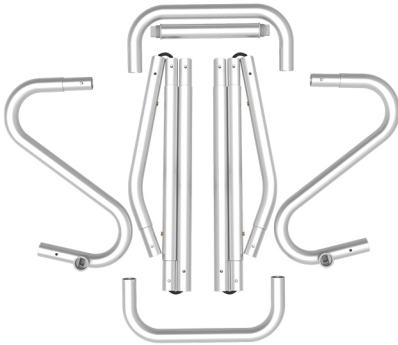

(2) Printed fabric banner



(3) Brochure rack x 2
Screws x 4

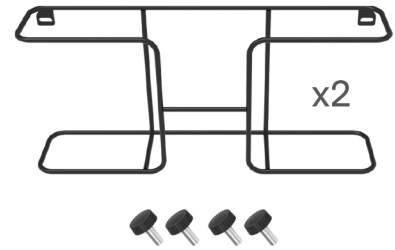

STEP 01

To Connect the tubes according to the labellings

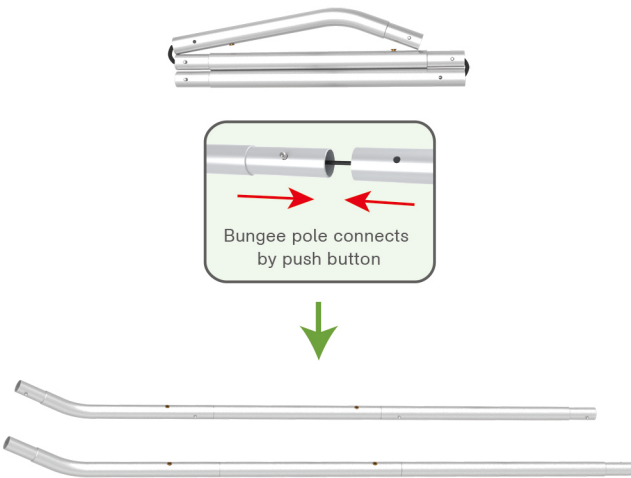

STEP 02

To connect 2 long side tubes by the corner pieces

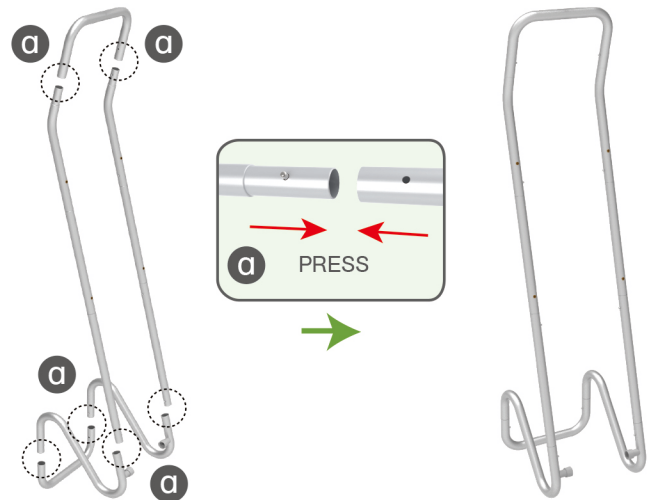

STEP 03

To install the cross bar according to labellings

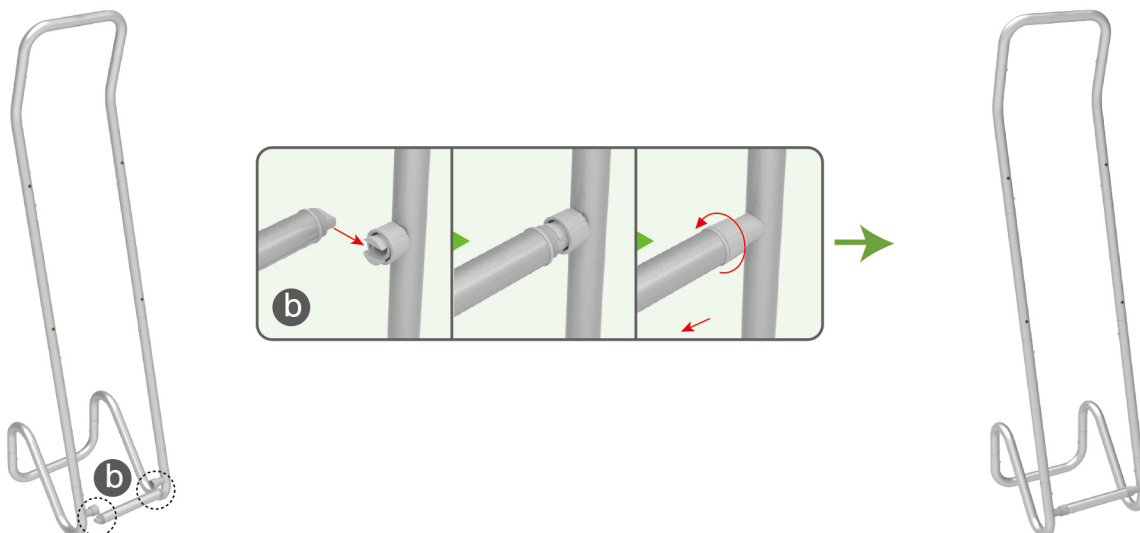

STEPS

STEP 04

To Wrap up the fabric banner from top to bottom and zip up.

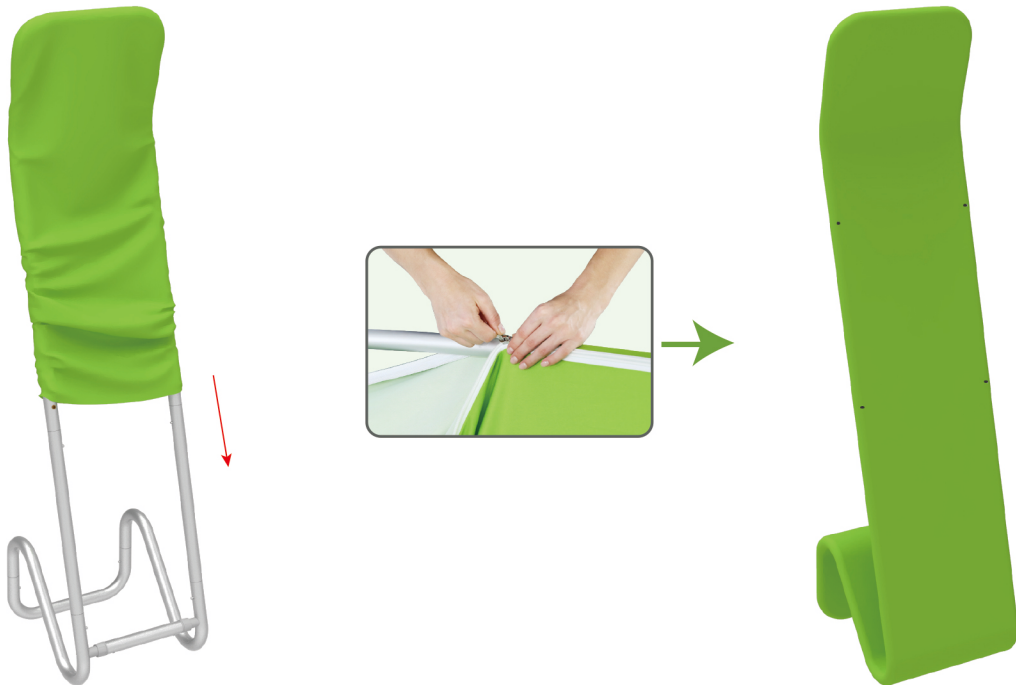

STEP 05

To install 2 racks by screws in position

