

INSTRUCTION

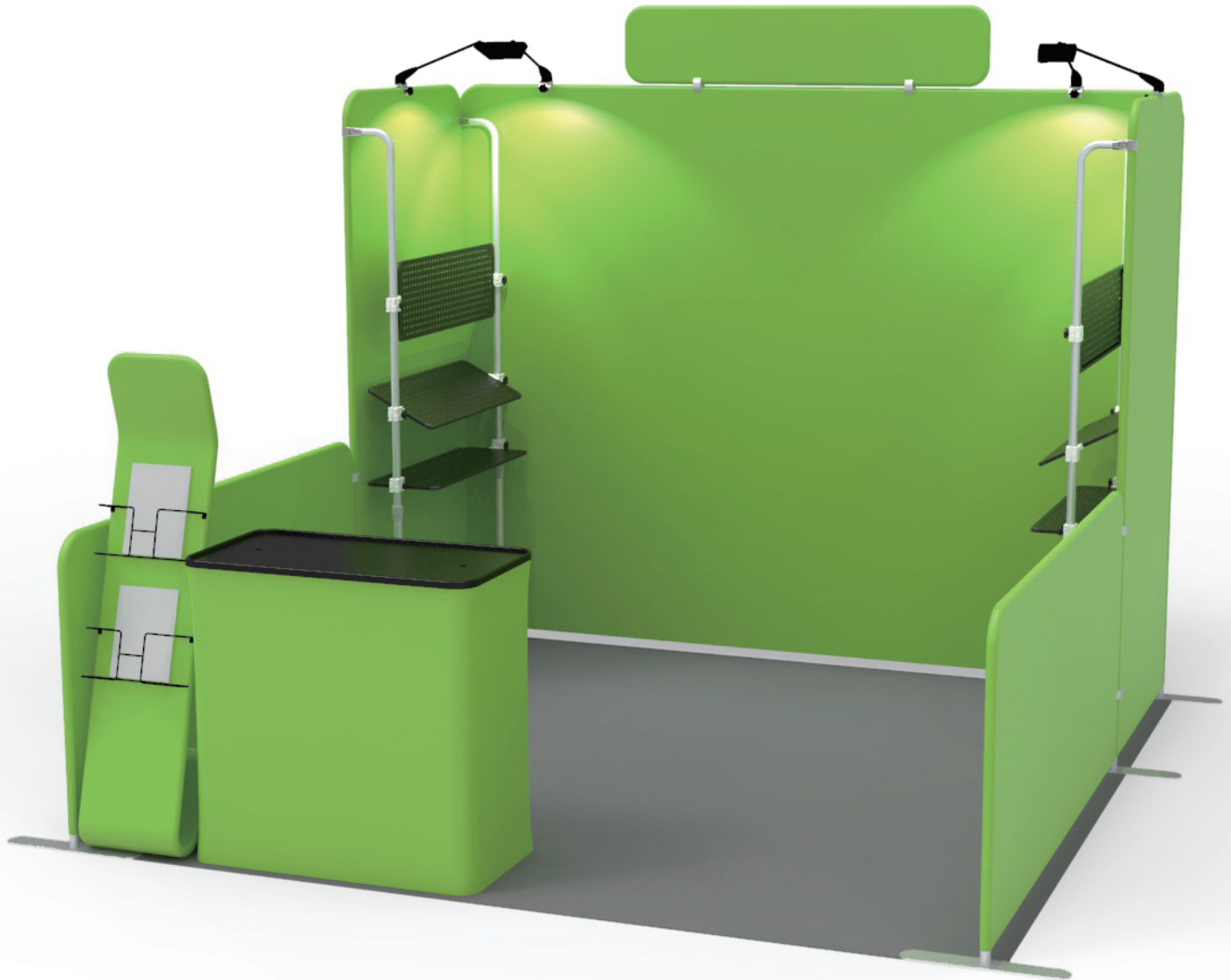

10X10FT-BOOTH-Y

STEPS

(1) Hardware

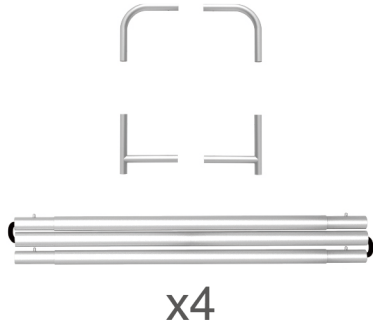

(2) Printed Graphic Fabric Banner (Optional)



STEP 01

Connect to make long poles according to labelings.

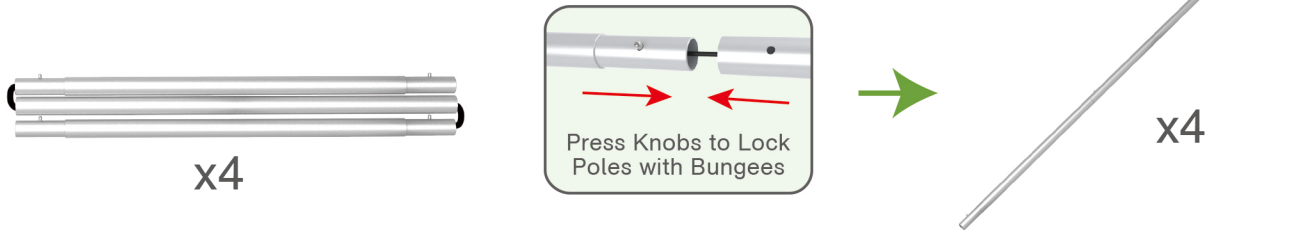

STEP 02

Connect long poles with corner poles according to labelings.

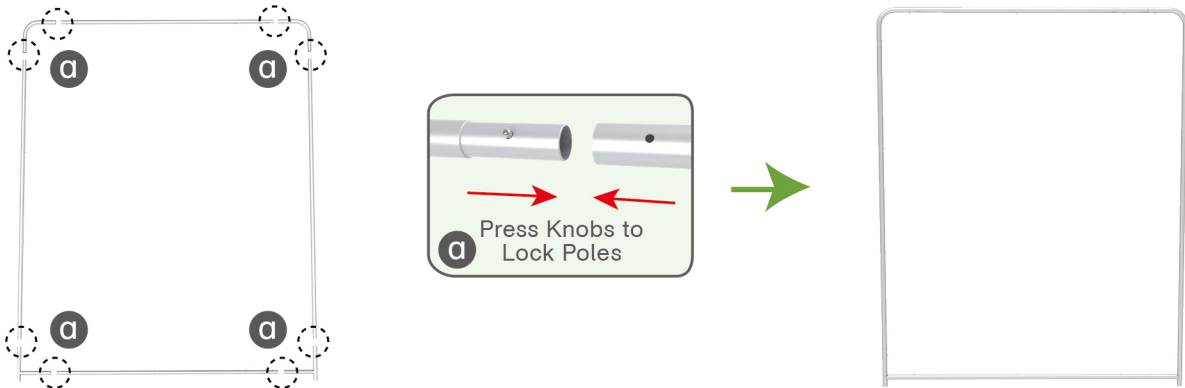

STEP 03

Slide fabric banner on frame from top and zip up at bottom.

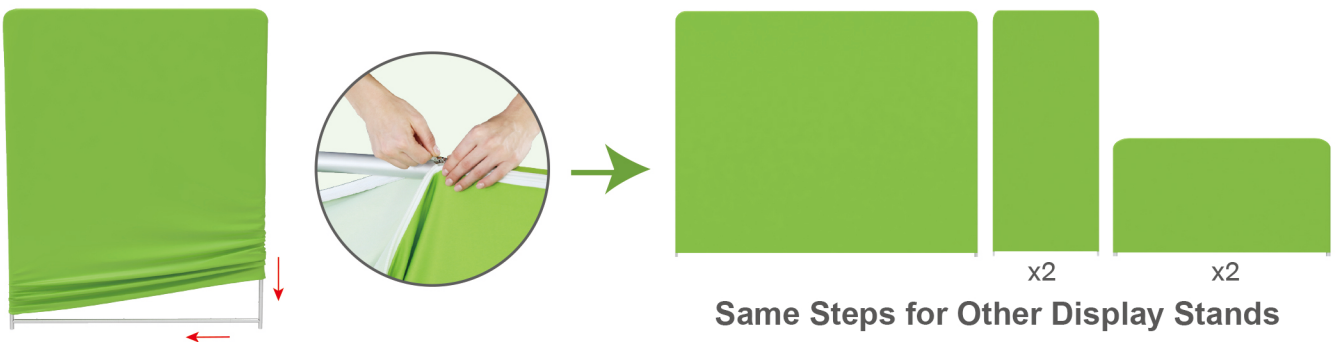

STEPS

(1) Hardware



(2) Printed Graphic Fabric Banner (Optional)



STEP 01

Connect poles according to labelings.

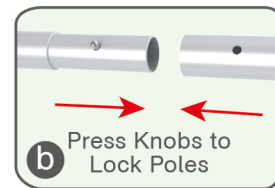
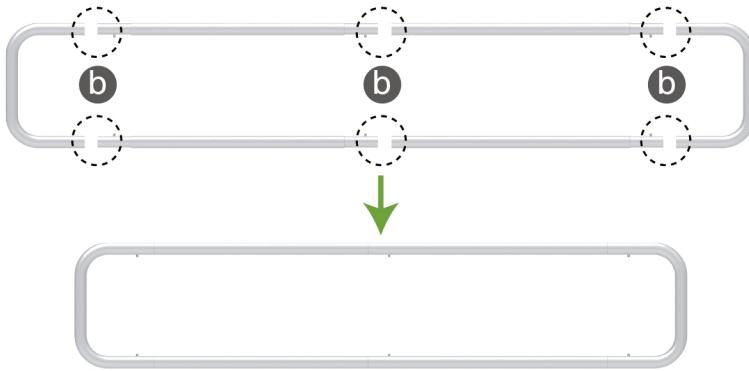

STEP 02

Slide fabric banner on frame from left and zip up at right.

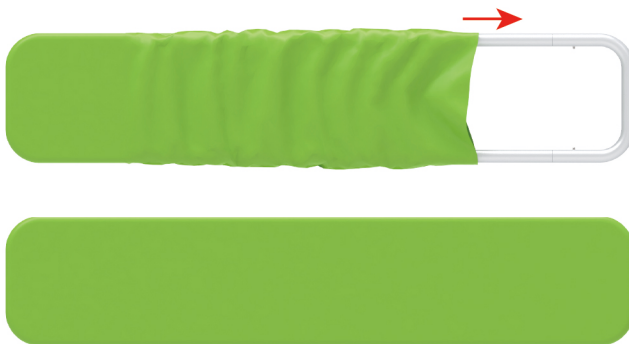

Booth Set Assembly

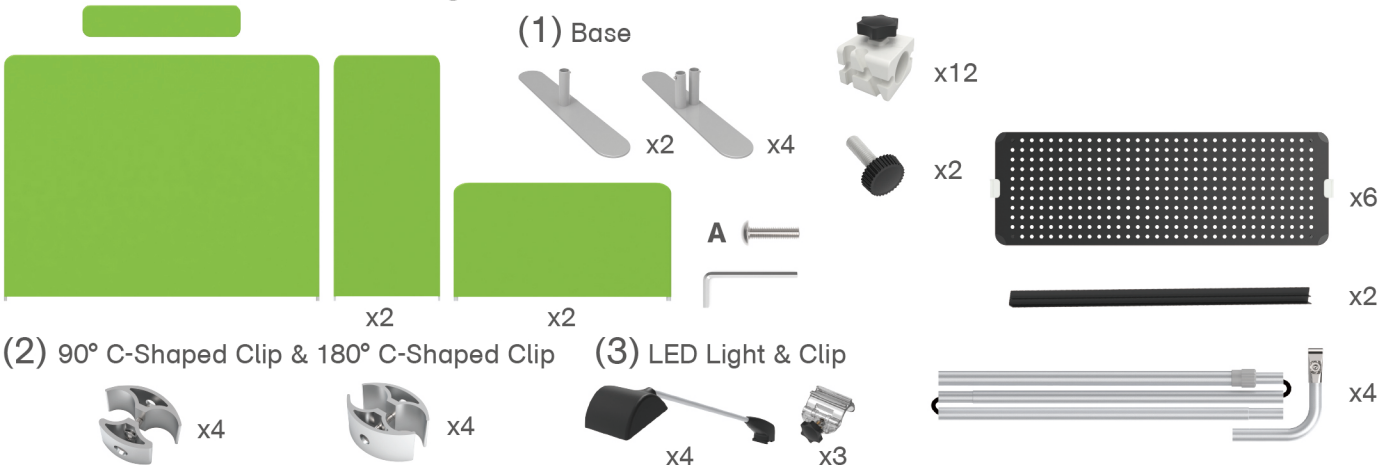

STEPS

STEP 01 Insert display stands onto feet by pressing their knobs.

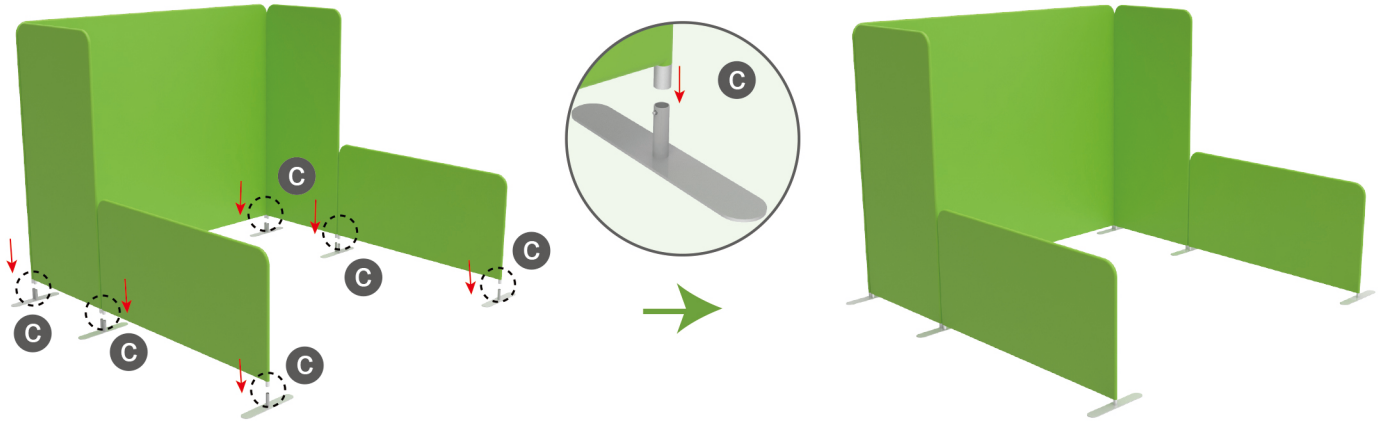

STEP 02

Connect to make long poles according to labelings, slide three-way clips onto long poles, insert short curved poles onto their top by pressing their knobs.

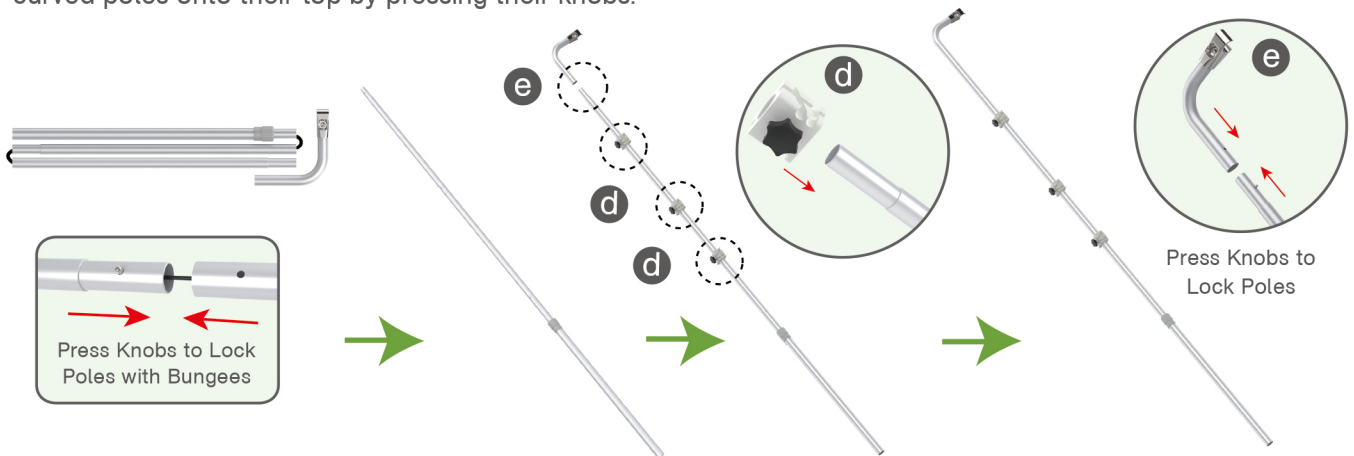

STEP 03

Connect long poles and display stand with clamps, adjust their height properly as needed by loosening and tightening screws.

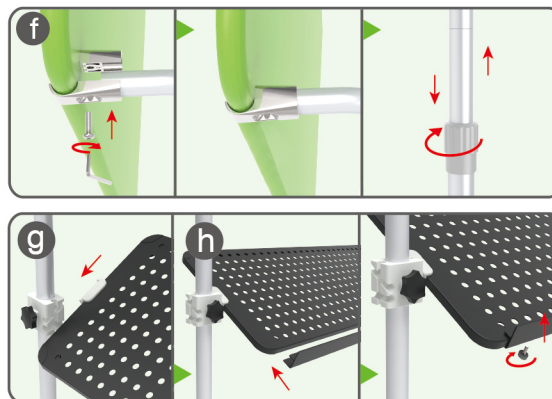
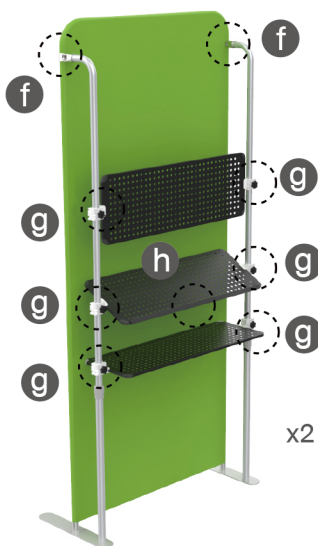

Clip into hanging boards based on directions of three-way clips & tightening with thumb screws, clip F-shaped bar onto hanging board with thumb screws.

STEPS

STEP 04 Interconnect display stands with C-shaped clips.

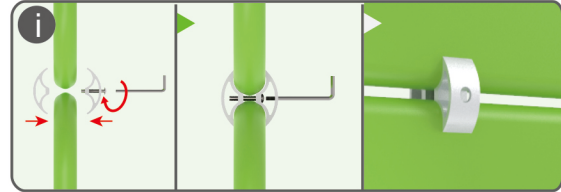
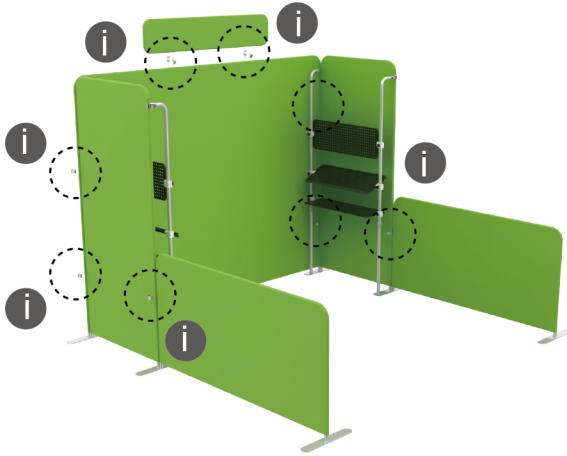

STEP 05 Screw light clips at top of display stands, slide lights onto them and adjust their direction.

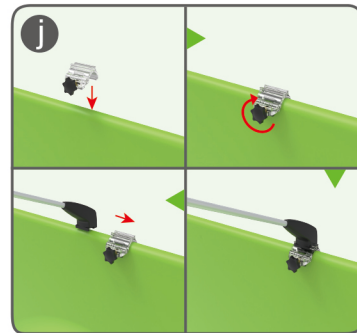
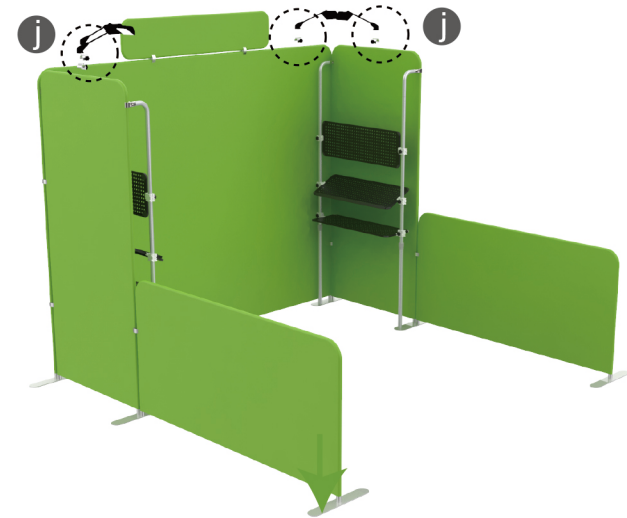

10X10FT-BOOTH-Y

STEPS

(1) Durable Plastic Hard Case, Aluminum Support Poles



(2) Printed Graphic Fabric Banner



STEP 01

Put hard case's top into fabric banner.

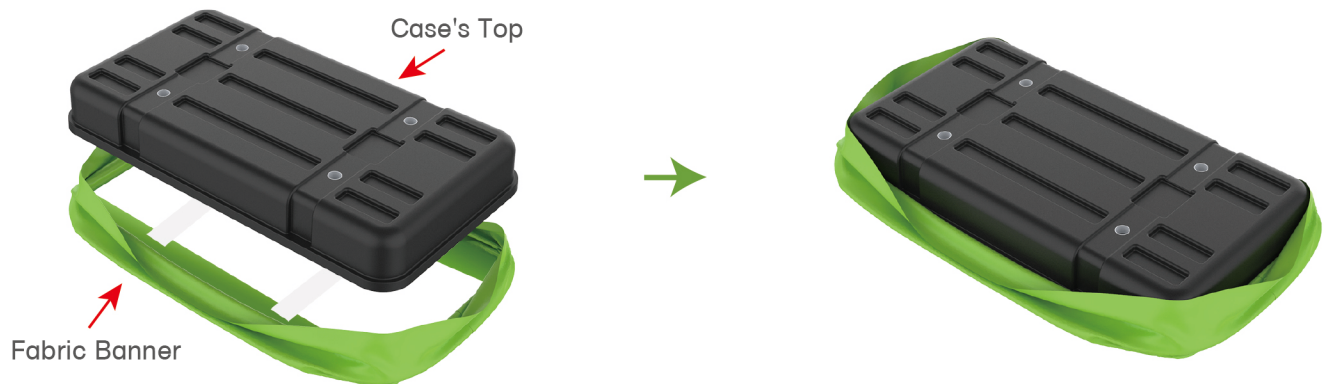

STEP 02

Insert support poles into hard case's top & bottom.

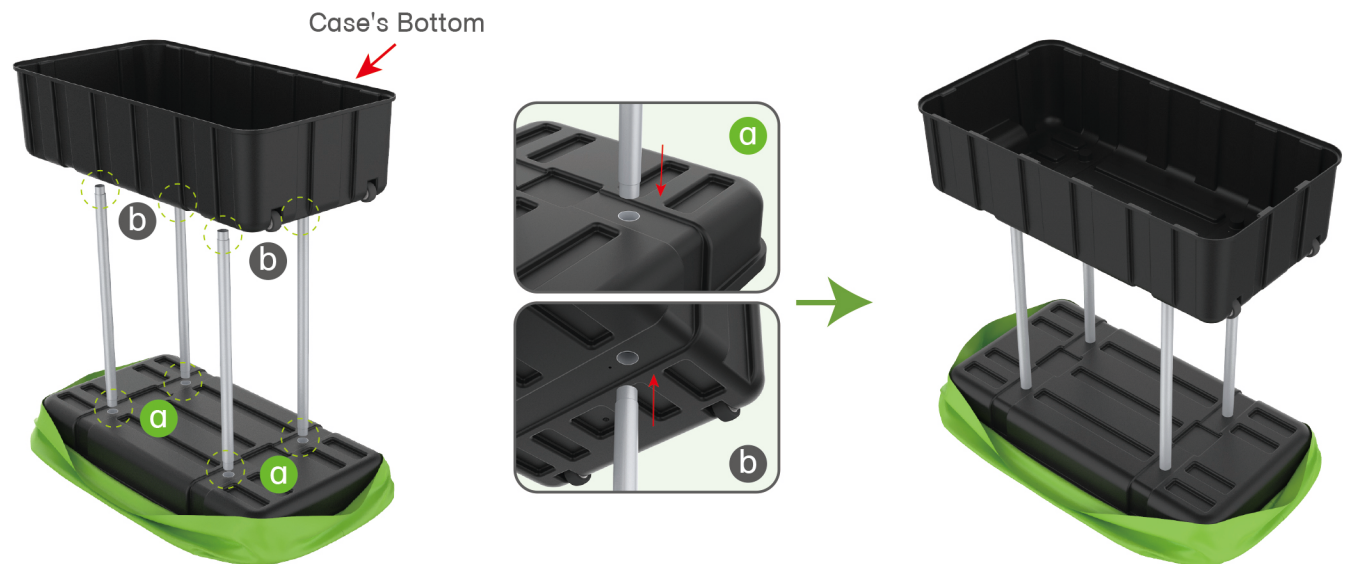

STEPS

STEP 04

Wrap fabric banner from bottom to top & twist it to be smooth, lay hard case's intermediate panel on podium's top.

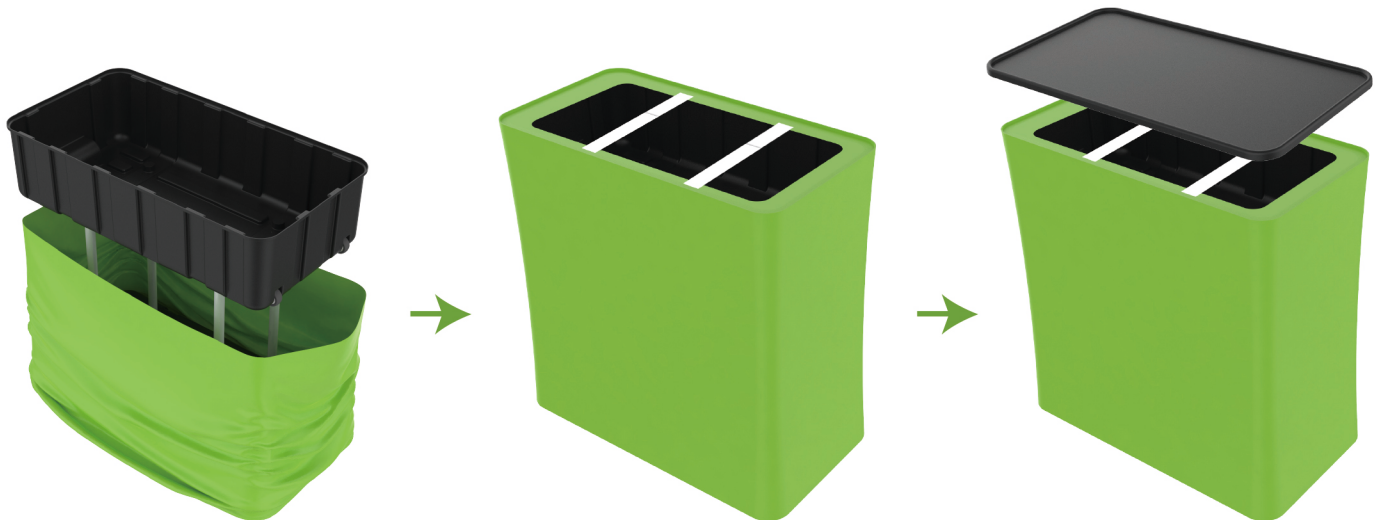

STEPS

(1) Snap Tubes

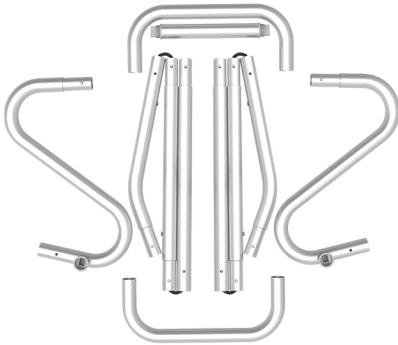

(2) Printed fabric banner



(3) Brochure rack x 2
Screws x 4

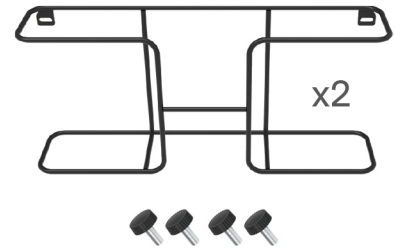

STEP 01

To Connect the tubes according to the labellings

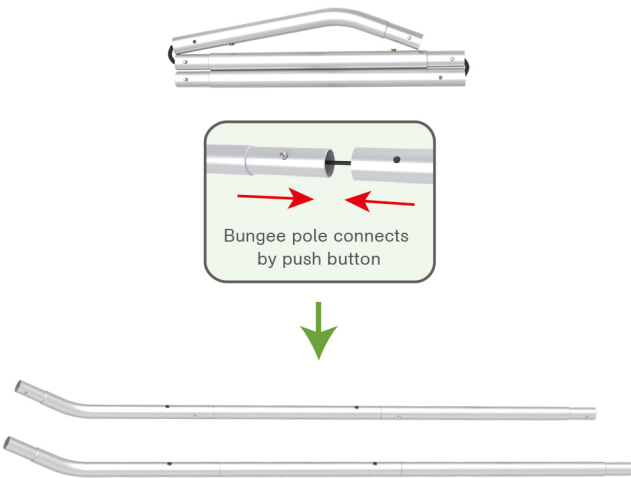

STEP 02

To connect 2 long side tubes by the corner pieces

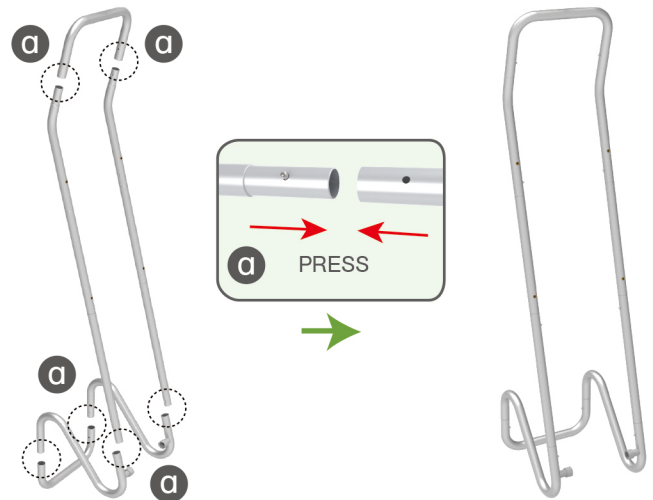

STEP 03

To install the cross bar according to labellings

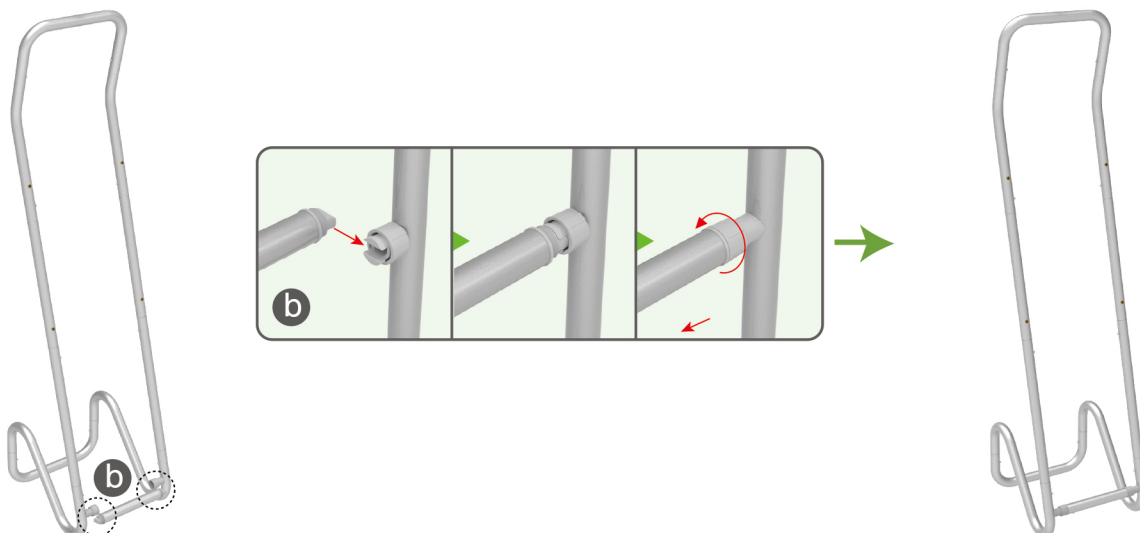

STEPS

STEP 04

To Wrap up the fabric banner from top to bottom and zip up.

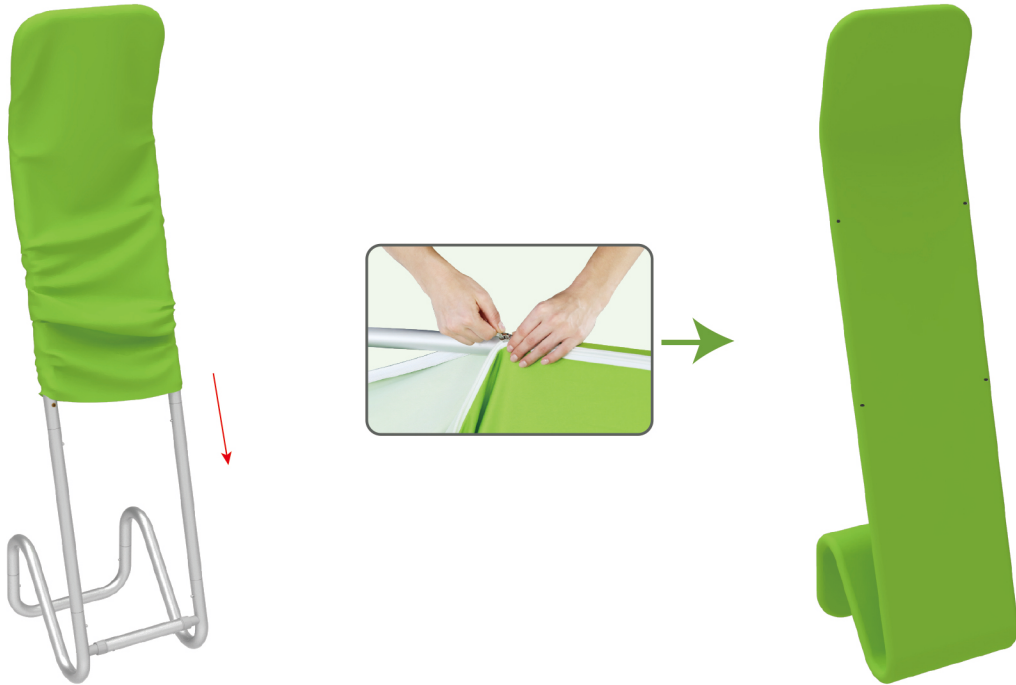

STEP 05

To install 2 racks by screws in position

